

RR 100



Efficiency class

C RR + accessories*

RRK 100



Alternative in corrosion-resistant and impact-resistant plastic casing.

SVR 100



Efficiency class

C SVR + accessories*

Dimensions RR 100

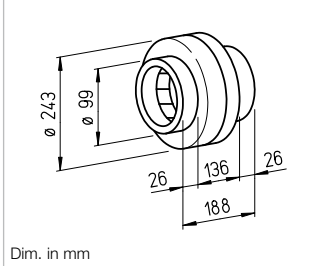

Dim. in mm

Dimensions RRK 100

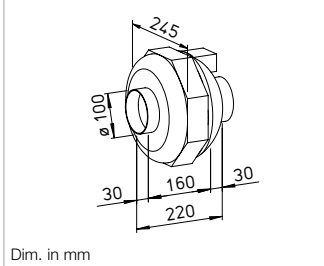

Dim. in mm

Dimensions SVR 100

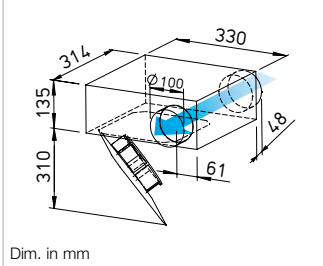

Dim. in mm

For the delivery of medium and small air volumes against high resistances.

Specifically designed for direct insertion in duct systems. High pressure performance for overcoming friction losses, deflection losses and aggregate resistances. For various applications in commercial, industrial and residential areas.

Special features

- Low space requirement and minimal installation costs due to linear throughflow.
- No need for elaborate deflectors.
- Connectors on inlet and outlet side correspond to standard duct Ø.
- Performance adjustment through 100% speed control.
- Can be used in any position.
- Wide range of accessories.
- Aerodynamically optimised casing design.

Common features

Motor

Enclosed, ball bearing mounted external rotor motor with humidity protection, insulation class F, for continuous operation, maintenance-free and radio interference-free.

Motor protection

Through built-in thermal contacts wired in series to the winding, automatic deactivation and reactivation after cooling.

Installation

No restrictions in any position (horizontal, vertical, diagonal) through corresponding installation for supply or extract ventilation (exception: SVR must not be installed with the retractable motor-impeller unit upward). Installation in duct system, preferably away from the room to be ventilated for less noise.

Noise

See page 398.

Description RR

Casing

Made of galvanised steel sheet, robust for harsh operating conditions. Inlet and outlet side connection dimensions correspond to standard duct Ø.

Power control

For type RR 100 A from 0–100% possible using electronic controller or step transformer (see table). For Type RR 100 C also two level operation using type DS 2/2 (accessories).

DS 2/2 Ref. no. 01267

Electrical connection

Terminal box (IP54) on outside of casing.

Impeller

Centrifugal, with backward curved blades made of plastic. Directly pressed on motor and dynamically balanced as a unit. Low-noise, high level of efficiency.

Protection category

Protection category IP44 through inlet and outlet-side installation in a duct system which prevents the ingress of rainwater.

Description RRK

Casing

All components made of corrosion-resistant and impact-resistant plastic. Six built-in guide blades additionally increase the level of efficiency. Colour: Silver-grey.

Power control

From 0 – 100 % possible using electronic controller or step transformer (see table).

Electrical connection

Terminal box (IP44) on outside of casing.

Impeller

Centrifugal, with backward curved blades made of plastic. Directly pressed on motor and dynamically balanced as a unit. Low-noise, high level of efficiency.

Protection category

IP44

Description SVR

Casing

Flat casing in compact design made of galvanised steel sheet. Connectors and lip seal on inlet and outlet side for standard duct Ø.

The retractable motor-impeller unit allows inspection and cleaning without dismantling components. The swivelling range must be considered for the inspection opening.

Power control

From 0 – 100 % possible using electronic controller or step transformer (see table) or two level operation with type DS 2/2 (accessories).

DS 2/2 Ref. no. 01267

Electrical connection

Terminal box (IP54) mounted to external cable.

Impeller

Energy-saving centrifugal impeller with backward curved blades made of high-quality plastic. Dynamically balanced for low-noise operation.

Protection category

IP44 with connected duct system.

Type	Ref. no.	Flow rate Free blowing	Rated speed	Sound press. case radiation	Power consum.	Power consump.		Wiring diagram	Max air flow temp.		Wgt net aprx.	Transformer speed controller 5-step	Electronic ³⁾ Speed controller, cont. var. flush-mount. / surf-mount.		
						at rated voltage	with control		at rated voltage	with control			Type	Ref. no.	Type
		V m ³ /h	min ⁻¹	dB(A) in 1 m	W	A	A	No.	+ °C	+ °C	kg	Type	Ref. no.	Type	Ref. no.
Type RR, Single-phase alternating current, 230 V, 50 Hz, Capacitor motor, IP44															
RR 100 A	05653	250	1730	36	41	0.18	0.18	508	60	60	2.9	TSW 0.3	03608	ESU 1 / ESA 1	00236 / 00238
RR 100 C ¹⁾	05654	330 ¹⁾ /220	2530 ¹⁾ /1655	42	62 ¹⁾ /40	0.27 ¹⁾ /0.18	0.27	934.1	60	60	2.9	TSW 0.3	03608	ESU 1 / ESA 1	00236 / 00238
Type RRK, Single-phase alternating current, 230 V, 50 Hz, Capacitor motor, IP44															
RRK 100	05973	290	2125	44	29	0.13	0.13	508	70	60	2.0	TSW 0.3	03608	ESU 1 / ESA 1	00236 / 00238
Type SVR, Single-phase alternating current, 230 V, 50 Hz, Capacitor motor, IP33															
SVR 100 C ²⁾	02658	310/245 ²⁾	2600/1940 ²⁾	45/40 ²⁾	58/40 ²⁾	0.25/0.18 ²⁾	0.23	934.1	60	60	4.8	TSW 1.5	01495	ESU 1 / ESA 1	00236 / 00238

¹⁾ Type with high speed; with additional energy-saving level as standard (see performance diagram). ²⁾ Values refer to the two performance levels (see performance diagram).

³⁾ Transformer control units must be provided in noise-relevant cases. Electronic phase angle control can cause disturbing magnetisation humming.

* See ErP product data sheet at www.HeliosSelect.de.

Performance curves RR 100 A

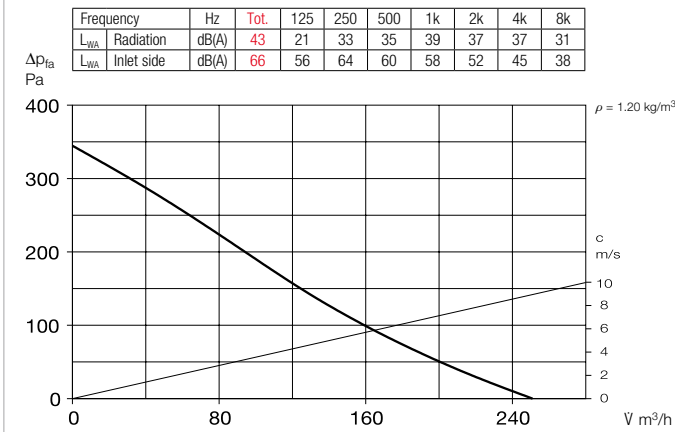

Performance curves RR 100 C

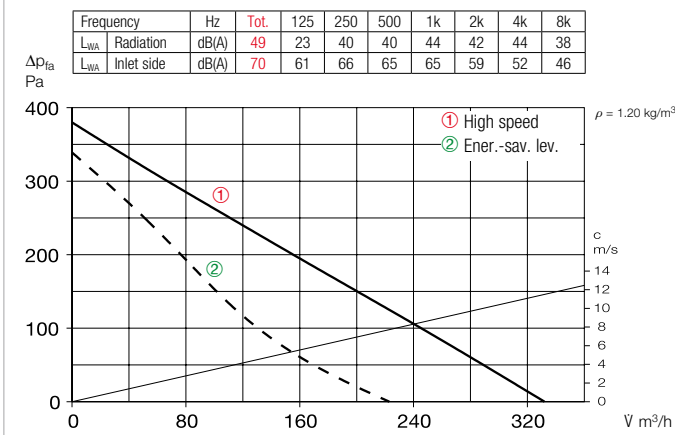

Performance curves RRK 100

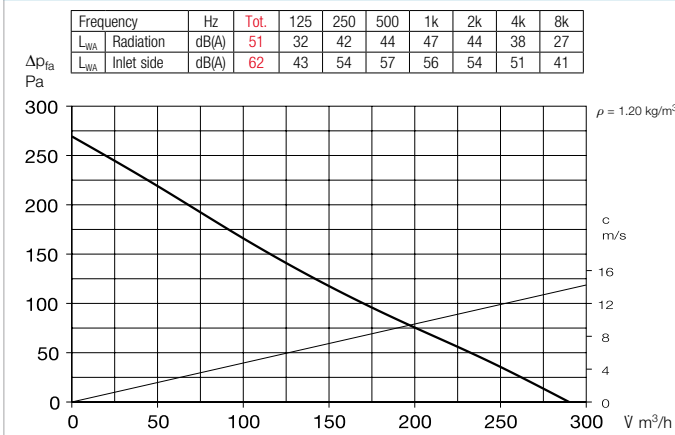

Performance curves SVR 100 C

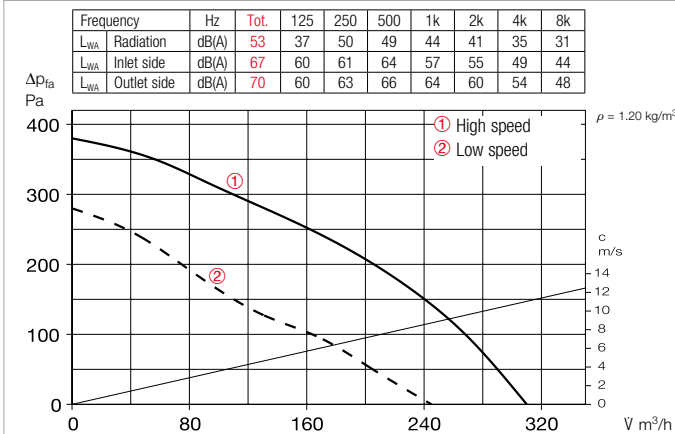

Accessories

Pipe clamp connectors

BM 100 Ref. no. 05075
For structure-borne noise-free connection of fan and piping and for suspension (1 set = 2 pcs). Mount ventilation duct and fan connector at a distance and fold sleeve over during installation.

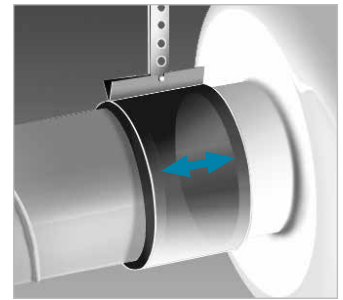

Mounting bracket for RR

MK 4 Ref. no. 05824

Mounting bracket for RRK

MK 1 Ref. no. 05821

Made of galvanised steel sheet.



External wall shutter

VK 100 Ref. no. 00757

Automatic made of plastic, white.



External wall cover grille

G 100 Ref. no. 00796

Made of plastic, white.



Protection grille

SGR 100 Ref. no. 05063

For inlet and outlet side installation. Made of powder-coated steel wire.



Duct shutter

RSKK 100 Ref. no. 05106

Automatic, made of plastic.



Flexible cross talk silencer

FSD 100 Ref. no. 00676

Made of aluminium pipe with double-sided plug-in connectors. Sound insulation lining 50 mm thick, installation length 1 m.



Air filter box

LFBR 100 Coarse 70%* 08576

LFBR 100 ePM1 50%* 08530

Air filter with large surface area, for installation in pipeline.



Electric heating element

EHR-R 0.4/100 0.4 kW No. 08708

In duct casing made of galvanised steel sheet.



Temperature control system for electric heating element

EHR-R

EHS Ref. no. 05002



Warm water heating element

WHR 100 Ref. no. 09479

Compact heat exchanger for installation in duct system.



Temperature control system for warm water heating element

WHST 300 T38 Ref. no. 08817

* See product page 484 for detailed description.